

T96G

Concealed Cam-Action Door Closer with Track Arm



FAULTLESS



Certificate:
1121-CPR-AD5073



Product Features:

- Adjustable power size 2~4
- Adjustable closing & latching speed
- Thermo-constant valve
- Concealed mount
- Cam action
- Track arm (Large as standard & Small as option)
- Single-action door
- Non-handed installation
- T96G can be installed in virtually all doors with minimum thickness of 40mm or more

- Power size 2~4
- Max. Door width (mm) 1100
- Max. Opening Angle 120

Application Ranges:

- Concealed in door
- Concealed in transom

Finishes:

- Anodized aluminum for door closer body and track rail as standard
- Painted – silver, brown, gold, black, white & other RAL colors upon request & discussion

Installation:

- Concealed in door

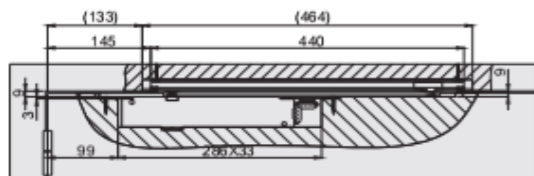

- Concealed in transom

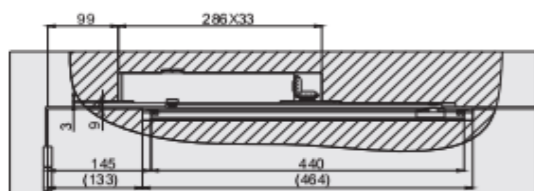

Dimensions:

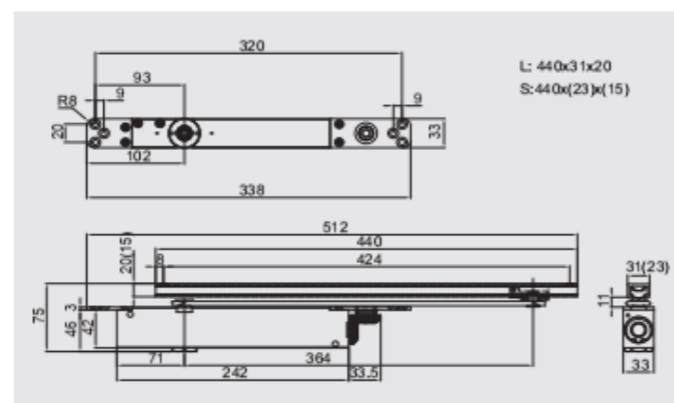

Accessories

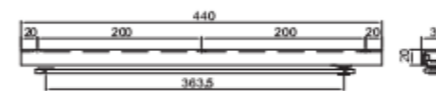

- ZAR-I150 (large)**
- Track arm & rail
 - EN Certified

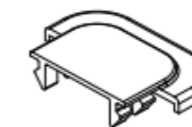

- ZSCR-T136**
- End Cap
 - For track arm & rail: ZAR-I150 (large)

Options

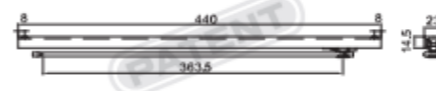

- ZAR-I145 (small)**
- Track arm & rail
 - Zinc alloy block (Patent #: M566248)
 - EN certified



- ZSCR-T012**
- End Cap
 - For track arm & rail: ZAR-I145 (Small)

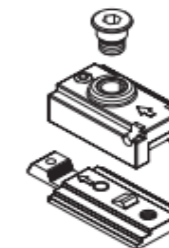

- ZSCR-T126**
- Hold-Open Device
 - For track arm & rail: ZAR-I150 (Large)

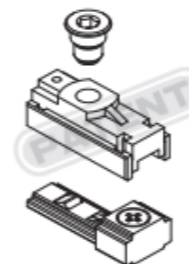

- ZSCR-T116**
- Hold-open device
 - Zinc alloy block (Patent #: M566248)
 - For track arm & rail: ZAR-I145 (small)

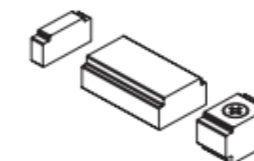

- ZSCR-T111**
- Cushion
 - For track arm & rail: ZAR-I150 (Large)

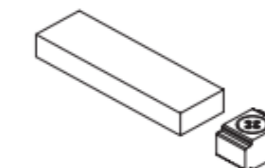

- ZSCR-T109**
- Cushion
 - For track arm & rail: ZAR-I145 (Small)