

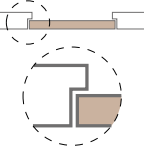

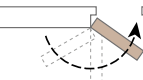

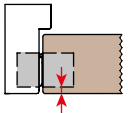

<p>MATERIAL</p> <p>Zamak</p>	<p>LOAD CAPACITY 60 kg (n.3 hinges)</p> 	<p>APPLICATION Flush to the wall door</p> 	<p>APPLICATION Self closing door</p>  <p>Adjustable self closing speed</p>
<p>K DISTANCE</p>  <p>K-max 4 mm</p>	<p>HINGE CENTERED ON THE DOOR LEAF</p>  <p>Max Thk 38 mm</p>		<p>OPENING ANGLE 180°</p> 
<p>3D ADJUSTMENTS</p>  <p>+3 / -3 +2 / -2 x1 / -1</p>	<p>FINISHING Full HD</p> 	<p>INTERCHANGEABLE WITH: K7080 / K7316</p> 	<p>COVER MATERIAL Aluminum</p> 
<p>NUMBER OF ROTATION AXES 7</p> 	<p>EN 1670</p> <p>Spray salt tested</p> <p>240 hours</p>	<p>MADE IN ITALY</p> 	

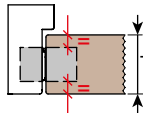
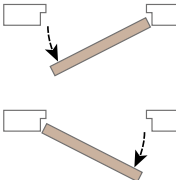
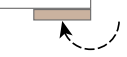
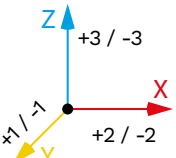

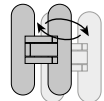
Classic Series

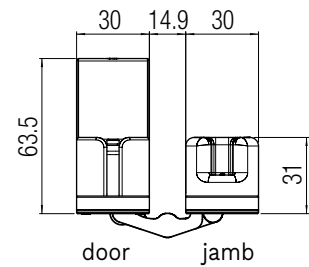
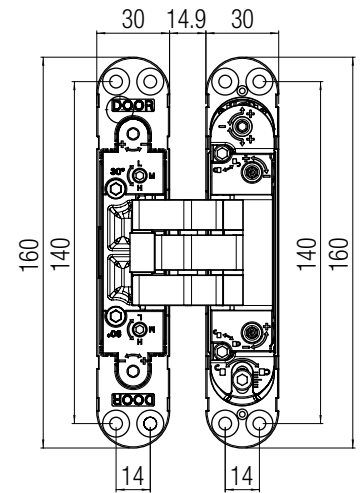
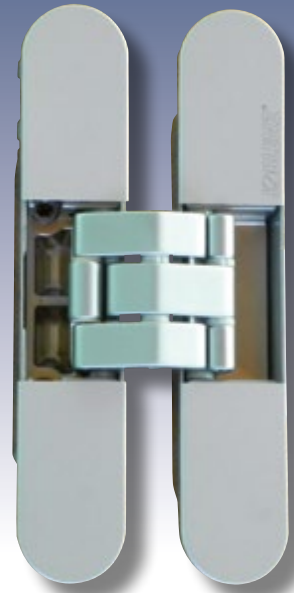

Product details:



Finishing

Colour	Item number.
	Satin chrome K 2000 CS HD
	Satin nickel K 2000 NS HD

For other colours please ask Krona Koblenz for feasibility

Load capacity table (see the reading guide at page 12)

		K2000 - 60 Kg - N.3 hinges							
Hinge spacing (mm)**	2000	60	60	60	60	60	59	57	
	1950	60	60	60	60	60	58	55	
	1900	60	60	60	60	59	56	54	
	1850	60	60	60	60	58	55	52	
	1800	60	60	60	59	56	54	51	
	1750	60	60	60	57	55	52	50	
	1700	60	60	59	56	53	51	48	
	1650	60	60	57	54	52	49	47	
	1600	60	60	55	53	50	48	45	
	1550	60	60	54	51	48	46	44	
	1500	60	59	52	49	47	45	43	
1450	60	57	50	48	45	43	41		
1730	60								
		900	700	800	900	950	1000	1050	1100
		Door leaf width (mm)**							

- Tested on doors: height 2100 mm - width 900 mm - opening angle 0°-90°.

**With door dimensions and max opening angle different from the tested configuration and/or with the application of other devices such as, for example, door closers/bumpers/emergency handle/dropdown seal/etc. refer to the "Installation Examples". Please note that testing for these configurations is under customer's responsibility. We specify that the combinations are the result of interpolation and not of real tests, which remain under the customer's responsibility.

Standard application

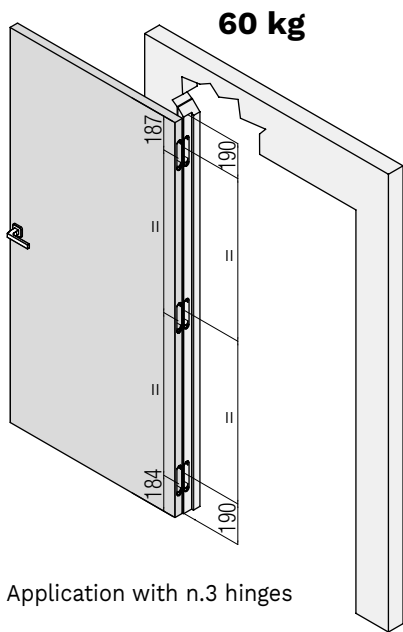

Milling door/jamb

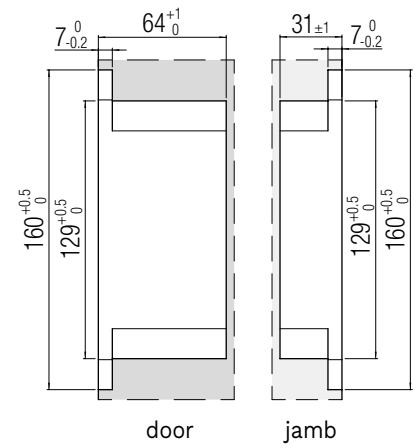

Installation of Hinge centered on the door leaf

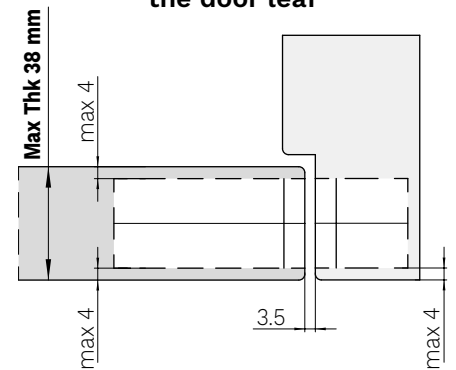

Installation of Hinge NOT centered on the door leaf

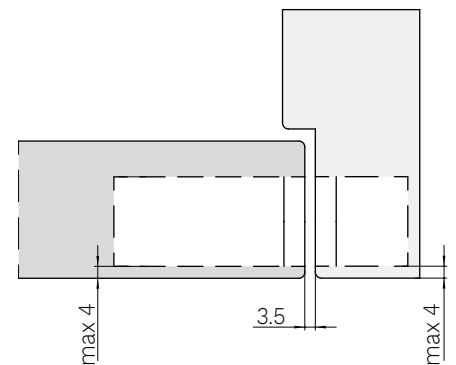

 **Fixing screws included**

The hinge fixing is ensured by using the **fixing screws** indicated in the hinge assembly instructions.